

IPVS High-pressure internal gear pumps Technical data sheet

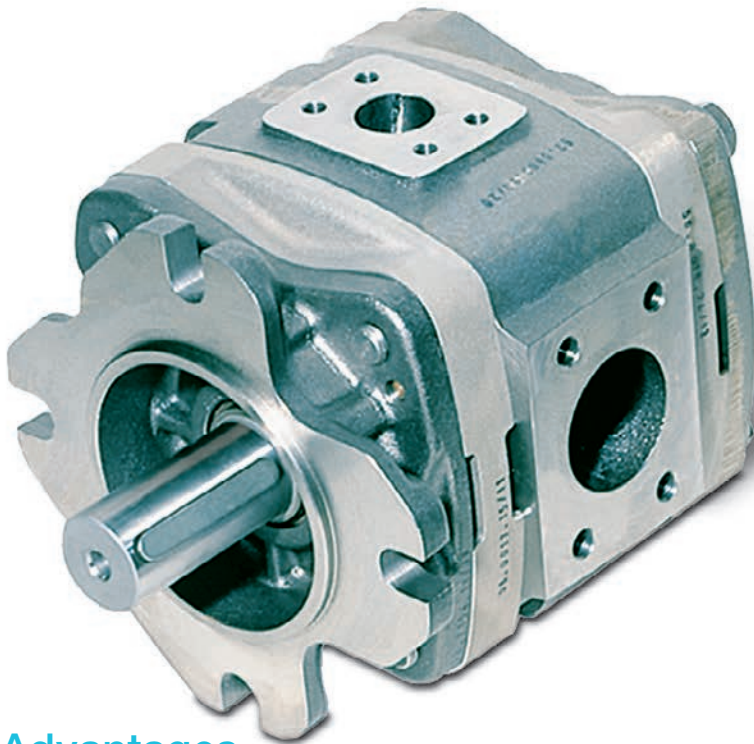

Advantages

- + High volumetric and overall efficiency
- + Very good pulsation behavior
- + Robust and compact
- + Low noise emission
- + Multiple flow capable

Design and function

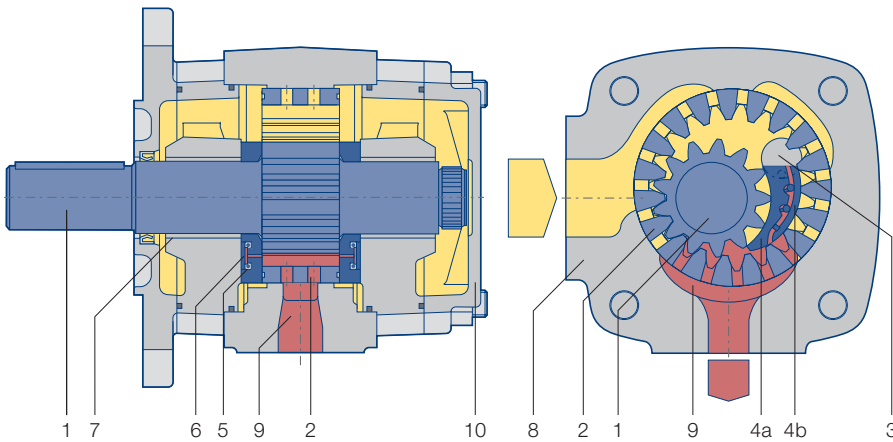

- 1 Pinion shaft
- 2 Internal gear
- 3 Filler pin
- 4a Filler segment carrier
- 4b Filler sealing segment
- 5 Axial disc
- 6 Axial pressure area
- 7 Plain bearings
- 8 Housing
- 9 Hydrostatic bearing
- 10 End cover with bleeder screw
- Suction chamber
- Pressure chamber

Function

By rotation of the gears inside the pump, the pressure fluid (usually hydraulic oil) is drawn into the cavity between the pinion and internal gear. Optimized cross-sectional areas on suction side as well as on pressure side allow operation over a wide range of speed.

In the radial direction, the gear chambers are closed by gear meshing and the filler piece. In the axial direction, the axial plates seal the pressure chamber with the minimal possible gap. This design minimizes volume losses and increases efficiency.

Calculations

Pump flow $Q = V_{gth} \cdot n \cdot \eta_v \cdot 10^{-3} \text{ [l/min]}$

Power $P = \frac{Q \cdot \Delta p}{600 \cdot \eta_g} \text{ [kW]}$

V_{gth} pump volume per revolution [cm³]

n Speed [rpm]

η_v Volumetric efficiency

η_g Overall efficiency

Δp Differential pressure [bar]

Technical data

Design	Internal gear pump with radial and axial sealing gap compensation
Type	IPVS
Mounting types	SAE hole flange; ISO 3019/1 or VDMA hole flange; ISO 3019/2
Line mounting	SAE suction and pressure flange J 518 C Code 61
Sense of rotation	right or left-hand rotation
Mounting position	any
Shaft load	for details of radial and axial drive shaft loads please contact J.M. Voith SE & Co. KG
Input pressure	0.8...3 bar absolute pressure (at start up for short time 0.6 bar)
Preload pressure. pressure port (in reversing mode)	for details please contact J.M. Voith SE & Co. KG
Pressure fluid	HLP mineral oils DIN 51524. part 2 or 3
Viscosity range	10 ... 300 mm ² s ⁻¹ (cSt)
Permissible start viscosity	max. 2 000 mm ² s ⁻¹ (cSt)
Permissible temperature of the pressure fluid	-20 ... +80 °C
Required purity of the pressure fluid	Class 19/17/14 (ISO 4406). Class 8 (NAS 1638)
Filtration	filtration quotient min. $\beta_{20} \geq 75$. recommended $\beta_{10} \geq 100$ (longer life)
Permissible ambient temperature	-20 ... +60 °C

Characteristics

Type, size – delivery	Displacement per revolution [cm ³]	Speed min. [rpm]	Speed max. [rpm]	Delivery at 1 500 rpm [l/min]	Con- tinuous pressure [bar]	Peak pressure at 1 500 rpm [bar]	Peak pressure at n _{max}	Moment of inertia [kg cm ²]
IPVS 3 – 3.5	3.6	400	3 600	5.4	345	420	330	0.34
IPVS 3 – 5	5.2	400	3 600	7.8	345	420	330	0.42
IPVS 3 – 6.3	6.4	400	3 600	9.6	345	420	330	0.49
IPVS 3 – 8	8.2	400	3 600	12.3	345	420	330	0.58
IPVS 3 – 10	10.2	400	3 600	15.3	345	420	330	0.70
IPVS 4 – 13	13.3	400	3 600	19.9	345	420	330	2.25
IPVS 4 – 16	15.8	400	3 400	23.7	345	420	330	2.64
IPVS 4 – 20	20.7	400	3 200	31.0	345	420	330	3.29
IPVS 4 – 25	25.4	400	3 000	38.1	315	380	300	3.70
IPVS 4 – 32	32.6	400	2 800	48.9	280	330	250	4.44
IPVS 5 – 32	33.1	400	3 000	49.6	345	420	315	8.62
IPVS 5 – 40	41.0	400	2 800	61.5	330	380	315	10.20
IPVS 5 – 50	50.3	400	2 500	75.4	300	345	280	11.60
IPVS 5 – 64	64.9	400	2 200	97.3	265	300	230	14.40
IPVS 6 – 64	64.1	400	2 600	96.1	345	420	300	25.73
IPVS 6 – 80	80.7	400	2 400	121.0	330	380	280	30.90
IPVS 6 – 100	101.3	400	2 100	151.9	300	345	250	36.10
IPVS 6 – 125	126.2	400	1 800	189.3	265	300	265	43.70
IPVS 7 – 125	125.8	400	2 200	188.7	345	420	300	84.05
IPVS 7 – 160	160.8	400	2 000	241.2	330	380	280	102.60
IPVS 7 – 200	202.7	400	1 800	304.0	300	345	300	119.00
IPVS 7 – 250	251.7	400	1 800	377.5	265	300	265	144.50

The values given apply for

- Pumping of mineral oils with a viscosity of 20 ... 40 mm²s⁻¹
- An input pressure of 0.8...3.0 bar absolute

Notes

- Peak pressures apply for 15 % of operating time with a maximum cycle time of 1 minute
- Please inquire about peak pressures at non-standard speeds
- Due to production tolerances, the pump volume may be reduced by up to 1.5 %.

IPVS Size 3, Rotation and dimensions (mounting flange 0, shaft end 1)

Rotation clockwise (cw)

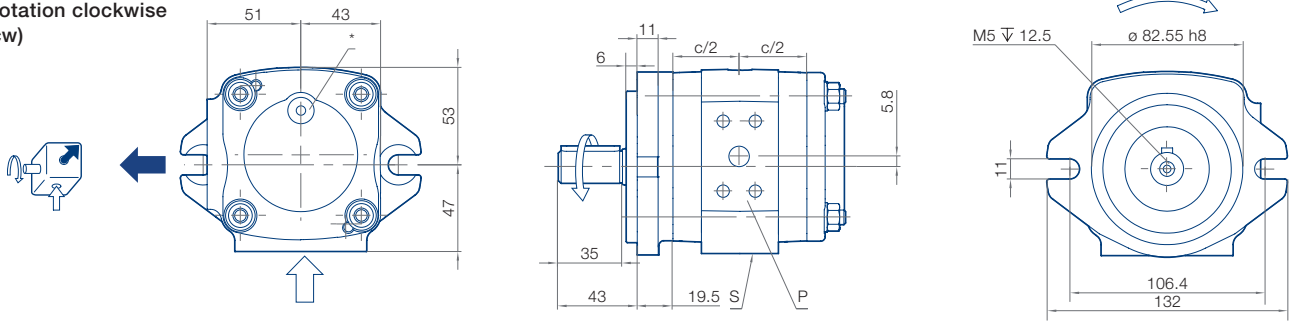

Rotation counter-clockwise (ccw)

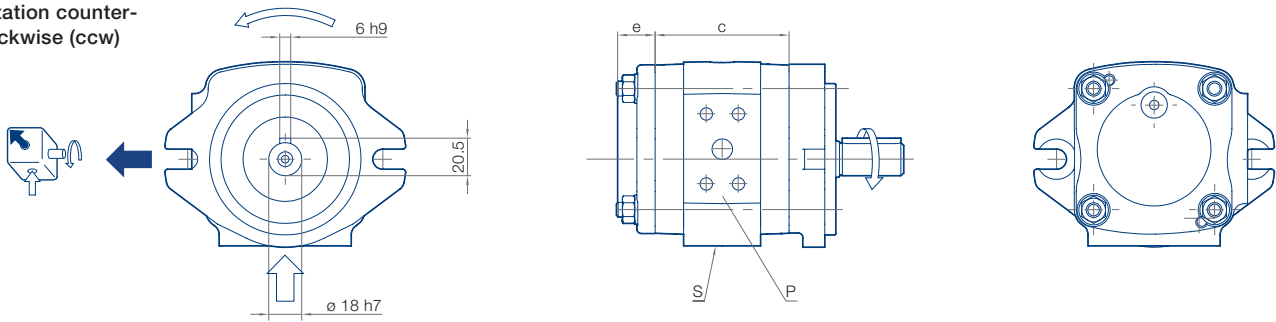

Pressure port (P)

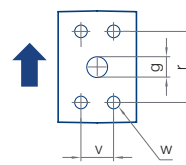

Suction port (S)

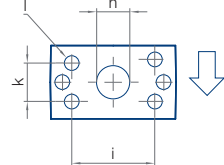

Type/ Delivery	c [mm]	e [mm]	g [mm]	h [mm]	i [mm]	k [mm]	l Thread	r [mm]	v [mm]	w Thread	Weight [kg]	SAE Flange No. ↑ ↓
IPVS 3 – 3.5	66	20.5	9	14	38.1	17.5	M8x13	40.5	18.2	M8x15	4.2	50 10
IPVS 3 – 5	70	20.5	11	14	38.1	17.5	M8x13	40.5	18.2	M8x15	4.4	50 10
IPVS 3 – 6.3	73	20.5	11	19	47.6	22.3	M10x15	40.5	18.2	M8x15	4.6	50 11
IPVS 3 – 8	77.5	20.5	13	19	47.6	22.3	M10x15	40.5	18.2	M8x15	4.8	50 11
IPVS 3 – 10	82.5	20.5	13	21	52.4	26.2	M10x15	40.5	18.2	M8x15	5.0	50 12

* Ensure the M10x1 plug screw, hexagon socket SW5, is tightened to a torque of 10 Nm during pumping operation. Dependent on the pump position, filling or ventilation is possible here prior to commissioning.

IPVS Size 3, Designs and dimensions

Rotation, Suction port

Mounting flange

Shaft end

Standard

Rotation clockwise,
Suction port pump

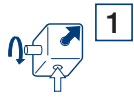

SAE 2-hole flange

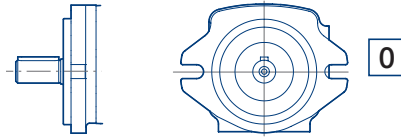

Keyway connection

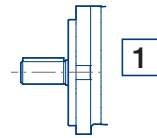

Variants

Rotation counterclockwise,
Suction port pump

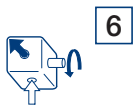

SAE 2-hole flange

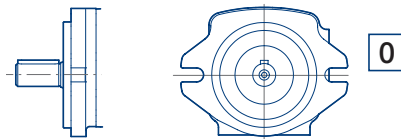

Keyway connection

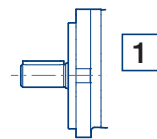

Rotation clockwise*,
Suction port pump

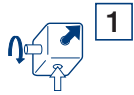

SAE 2-hole flange

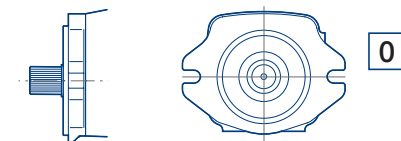

Involute gearing

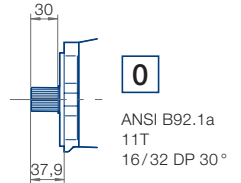

Rotation counterclockwise*,
Suction port pump

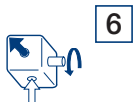

VDMA-2-hole flange

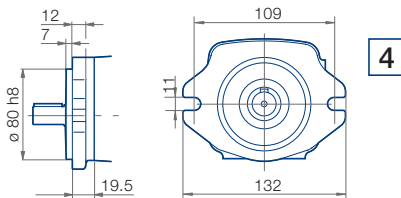

Keyway connection

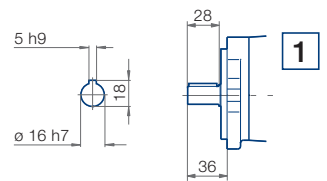

* Direction of rotation free selectable in the illustrated mounting flange/shaft end combination.

IPVS Size 4, Rotation and dimensions (mounting flange 7, shaft end 1)

Rotation clockwise (cw)

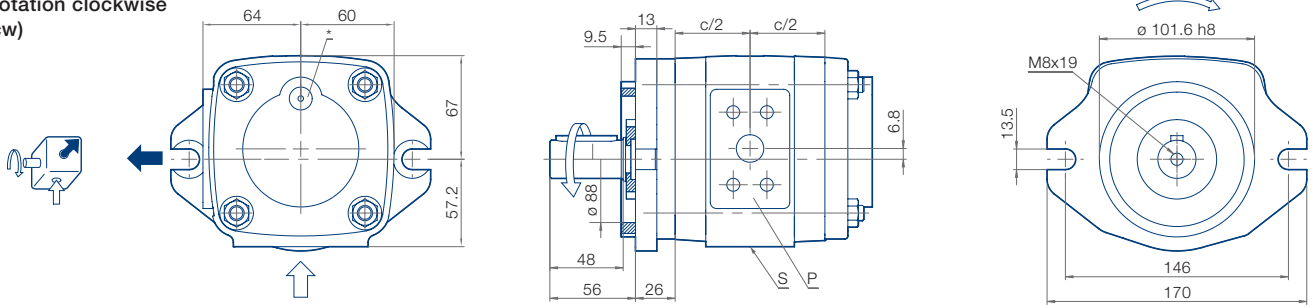

Rotation counter-clockwise (ccw)

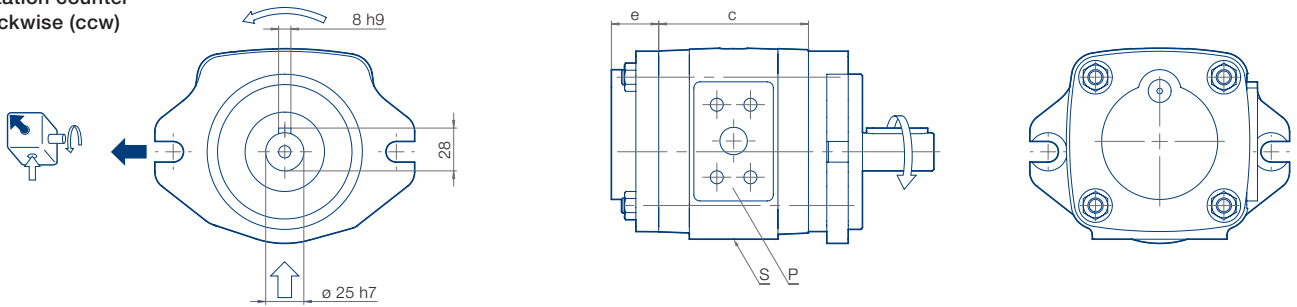

Pressure port (P)

Suction port (S)

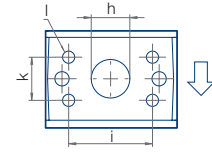
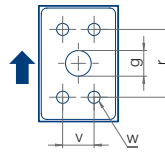

Type/ Delivery	c [mm]	e [mm]	g [mm]	h [mm]	i [mm]	k [mm]	l Thread	r [mm]	v [mm]	w Thread	Weight [kg]	SAE Flange No. ↑ ↓
IPVS 4 – 13	88.5	31	13	23	52.4	26.2	M10x15	40.5	18.2	M8x15	9.4	50 12
IPVS 4 – 16	92.5	31	14	25	52.4	26.2	M10x15	40.5	18.2	M8x15	9.7	50 12
IPVS 4 – 20	98	31	18	27	58.7	30.2	M10x15	50.8	23.8	M10x17	10.2	51 13
IPVS 4 – 25	104	31	18	30	58.7	30.2	M10x15	50.8	23.8	M10x17	10.7	51 13
IPVS 4 – 32	113	31	18	32	58.7	30.2	M10x15	50.8	23.8	M10x17	11.7	51 13

* Ensure the M10x1 plug screw, hexagon socket SW5, is tightened to a torque of 10 Nm during pumping operation. Dependent on the pump position, filling or ventilation is possible here prior to commissioning.

IPVS Size 4, Designs and dimensions

Rotation, Suction port

Mounting flange

Shaft end

Standard

Rotation clockwise,
Suction port pump

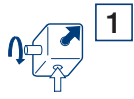

SAE 2-hole flange

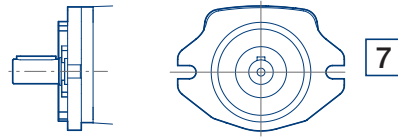

Keyway connection

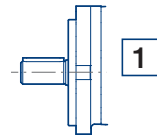

Variants

Rotation counterclockwise,
Suction port pump

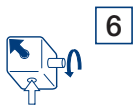

SAE 2-hole flange

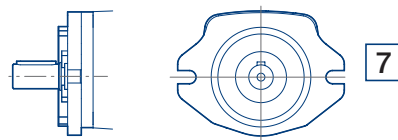

Keyway connection

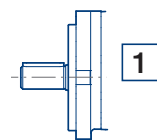

Rotation clockwise*,
Suction port pump



SAE 2-hole flange

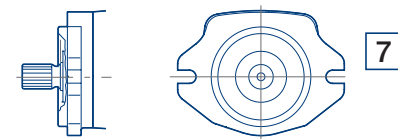

Involute gearing

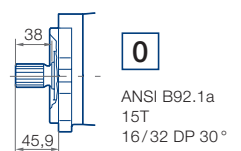

Rotation counterclockwise*,
Suction port pump

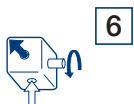

SAE 4-hole flange

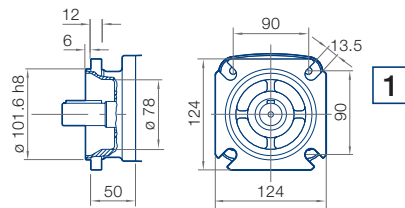

Keyway connection

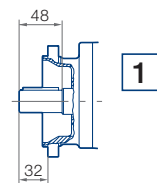

VDMA-4-hole flange

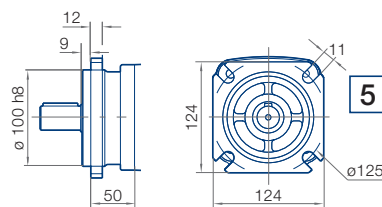

Keyway connection

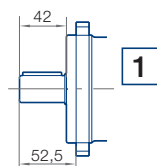

* Direction of rotation free selectable in the illustrated mounting flange/shaft end combination.

IPVS Size 5, Rotation and dimensions (mounting flange 0, shaft end 1)

Rotation clockwise (cw)

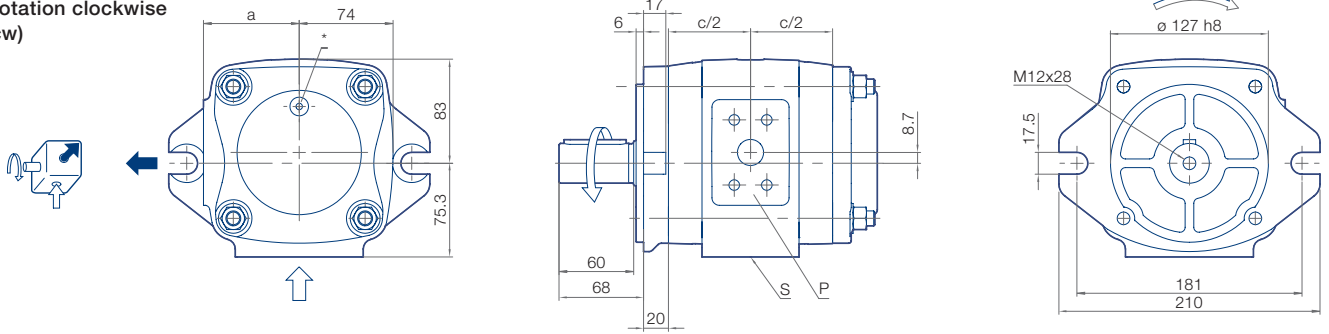

Rotation counter-clockwise (ccw)

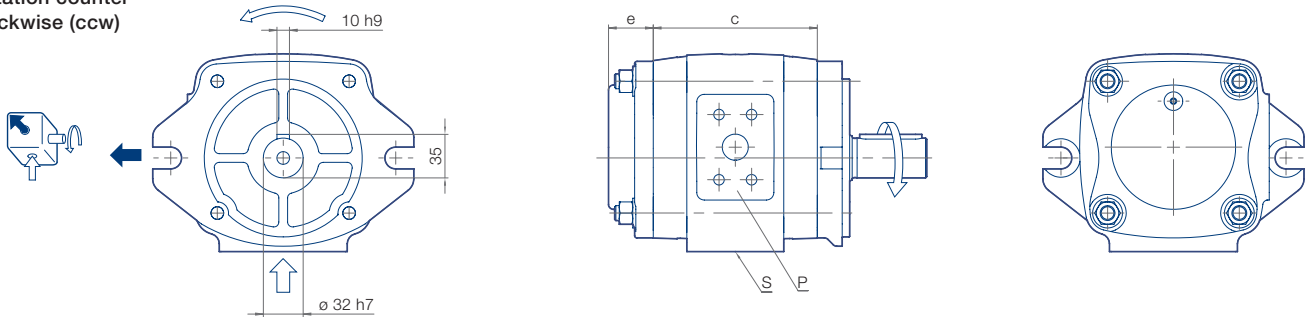

Pressure port (P)

Suction port (S)

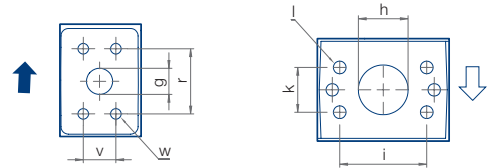

Type/ Delivery	a [mm]	c [mm]	e [mm]	g [mm]	h [mm]	i [mm]	k [mm]	l Thread	r [mm]	v [mm]	w Thread	Weight [kg]	SAE Flange No. ↑	SAE Flange No. ↓
IPVS 5 – 32	77	119	36	18	32	58.7	30.2	M10x15	50.8	23.8	M10x16.5	15.6	51	13
IPVS 5 – 40	77	125	36	19	35	69.9	35.7	M12x20	50.8	23.8	M10x16.5	16.7	51	30
IPVS 5 – 50	83	132	36	21	40	69.9	35.7	M12x20	57.2	27.8	M12x22	17.3	52	30
IPVS 5 – 64	83	143	36	23	40	69.9	35.7	M12x20	57.2	27.8	M12x22	19.1	52	30

* Ensure the M10x1 plug screw, hexagon socket SW5, is tightened to a torque of 10 Nm during pumping operation.
Dependent on the pump position, filling or ventilation is possible here prior to commissioning.

Note! In case of oil-immersed installation of the oil pump flange variant 0 can not be used. For this special case, the flange version 7 will be used.

IPVS Size 5, Designs and dimensions

Rotation, Suction port

Mounting flange

Shaft end

Standard

Rotation clockwise,
Suction port pump

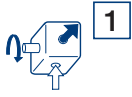

SAE 2-hole flange

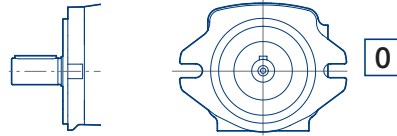

Keyway connection

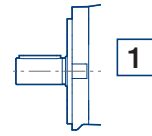

Variants

Rotation counterclockwise,
Suction port pump

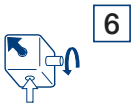

SAE 2-hole flange

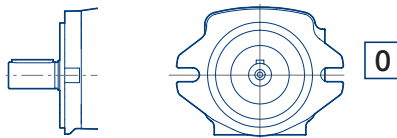

Keyway connection

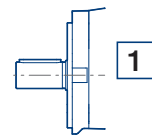

Rotation clockwise*,
Suction port pump

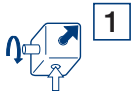

SAE 2-hole flange

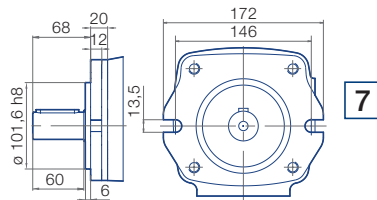

Keyway connection

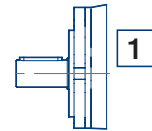

Rotation counterclockwise*,
Suction port pump

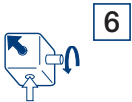

SAE 2-hole flange

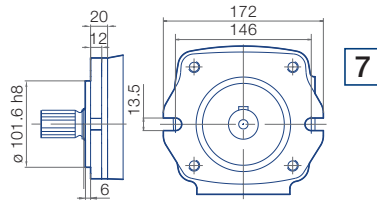

Involute gearing

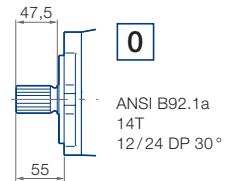

SAE 4-hole flange

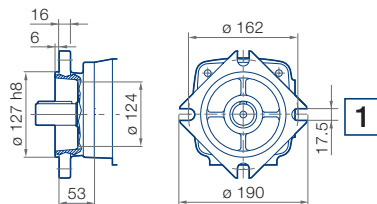

Keyway connection

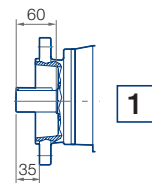

VDMA-4-hole flange

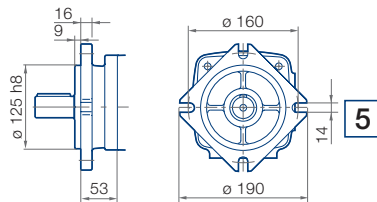

Keyway connection

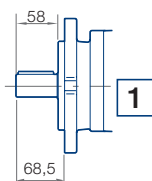

* Direction of rotation free selectable in the illustrated mounting flange/shaft end combination.

IPVS Size 6, Rotation and dimensions (mounting flange 0, shaft end 1)

Rotation clockwise (cw)

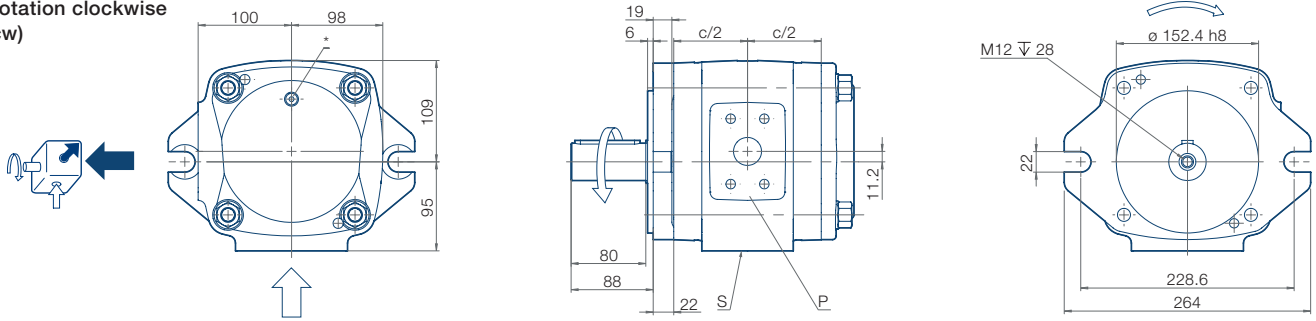

Rotation counter-clockwise (ccw)

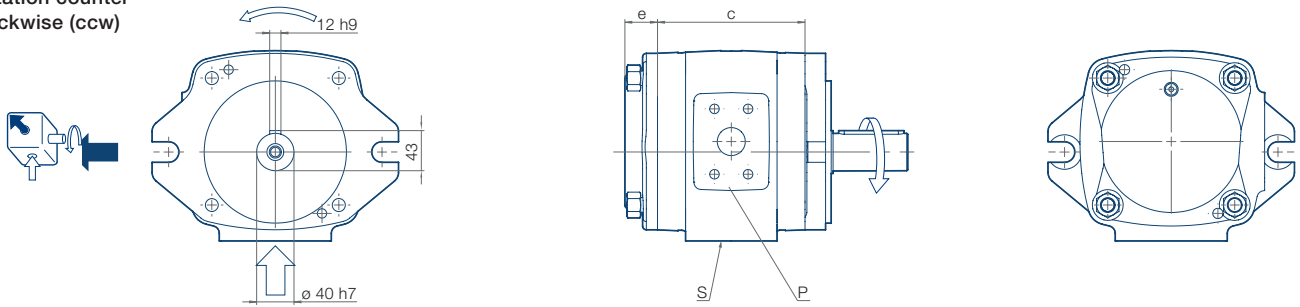

Pressure port (P)

Suction port (S)

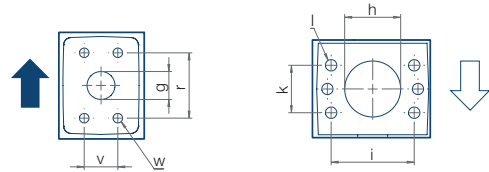

Type/ Delivery	c [mm]	e [mm]	g [mm]	h [mm]	i [mm]	k [mm]	l Thread	r [mm]	v [mm]	w Thread	Weight [kg]	SAE Flange No. ↑ ↓
IPVS 6 – 64	140	40	23	40	69.9	35.7	M12x20	57.2	27.8	M12x22	30.0	52 30
IPVS 6 – 80	148	35	23	45	77.8	42.9	M12x20	66.6	31.8	M14x24	31.7	53a 15
IPVS 6 – 100	158	35	27	50	77.8	42.9	M12x20	66.6	31.8	M14x24	33.0	53a 15
IPVS 6 – 125	170	40	30	50	77.8	42.9	M12x20	66.6	31.8	M14x24	36.0	53a 15

* Ensure the M10x1 plug screw, hexagon socket SW5, is tightened to a torque of 10 Nm during pumping operation. Dependent on the pump position, filling or ventilation is possible here prior to commissioning.

IPV Size 6, Designs and dimensions

Rotation, Suction port

Mounting flange

Shaft end

Standard

Rotation clockwise,
Suction port pump

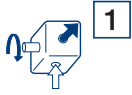

SAE 2-hole flange

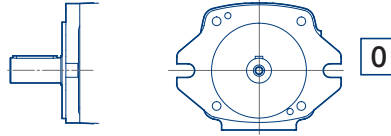

Keyway connection

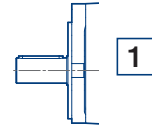

Variants

Rotation counterclockwise,
Suction port pump

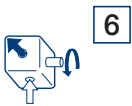

SAE 2-hole flange

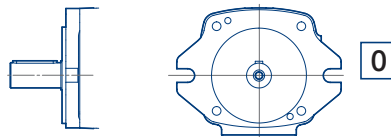

Keyway connection

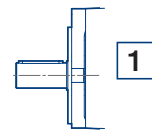

Rotation clockwise*,
Suction port pump

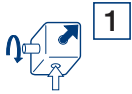

SAE 2-hole flange

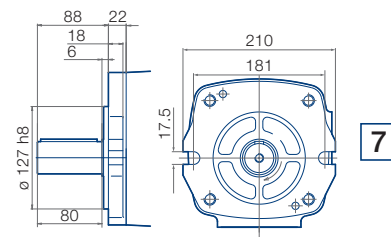

Keyway connection

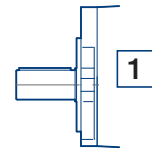

Rotation counterclockwise*,
Suction port pump

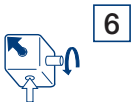

SAE 2-hole flange

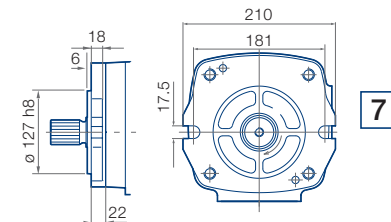

Involute gearing

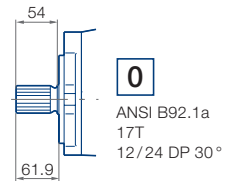

SAE 4-hole flange

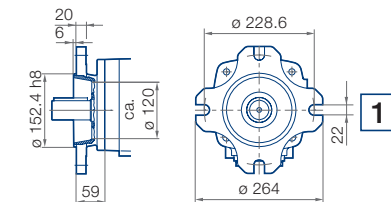

Keyway connection

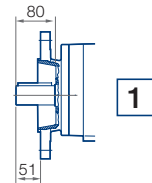

VDMA-4-hole flange

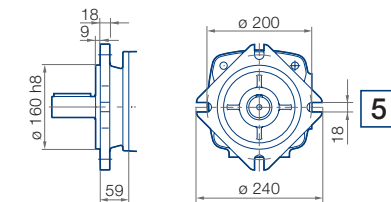

Keyway connection

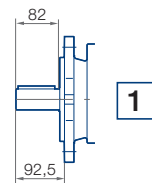

* Direction of rotation free selectable in the illustrated mounting flange / shaft end combination.

IPVS Size 7, Rotation and dimensions (mounting flange 1, shaft end 1)

Rotation clockwise
(cw)

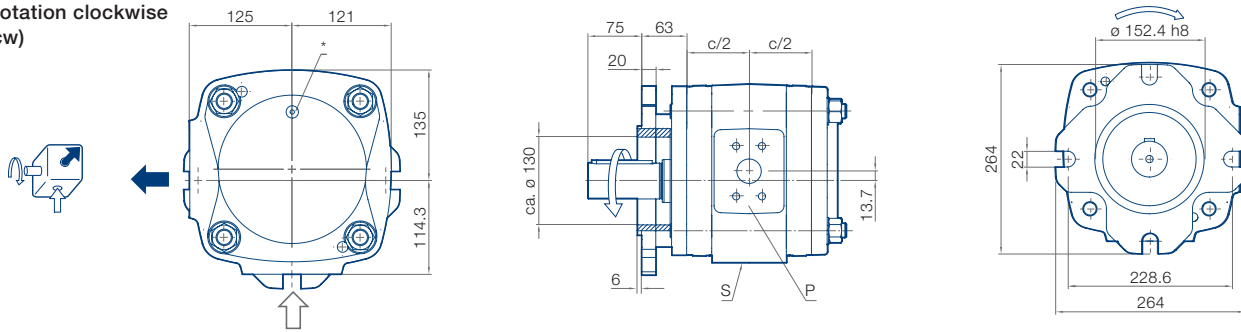

Rotation counter-
clockwise (ccw)

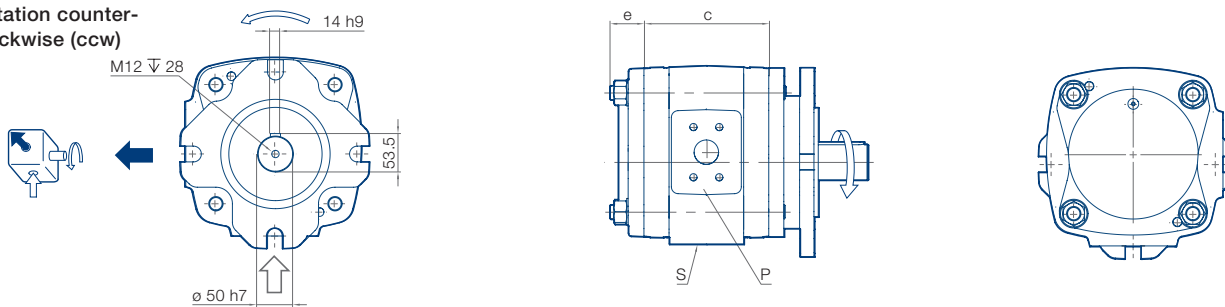

Pressure port (P)

Suction port (S)

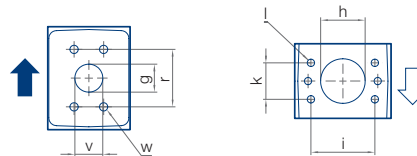

Type/ Delivery	c [mm]	e [mm]	g [mm]	h [mm]	i [mm]	k [mm]	l Thread	r [mm]	v [mm]	w Thread	Weight [kg]	SAE Flange No. ↑ ↓
IPVS 7 – 125	152	48	30	50	77.8	42.9	M12x20	66.6	31.8	M14x24	46.5	53a 15
IPVS 7 – 160	162	48	30	56	88.9	50.8	M12x20	66.6	31.8	M14x24	50.0	53a 16
IPVS 7 – 200	174	46	34	62	88.9	50.8	M12x20	79.3	36.5	M16x26	54.0	54 16
IPVS 7 – 250	188	42	38	72	106.4	61.9	M16x25	79.3	36.5	M16x26	59.0	54 17

* Ensure the M10x1 plug screw, hexagon socket SW5, is tightened to a torque of 10 Nm during pumping operation.
Dependent on the pump position, filling or ventilation is possible here prior to commissioning.

IPV Size 7, Designs and dimensions

Rotation, Suction port

Mounting flange

Shaft end

Standard

Rotation clockwise,
Suction port pump

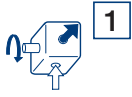

SAE 4-hole flange

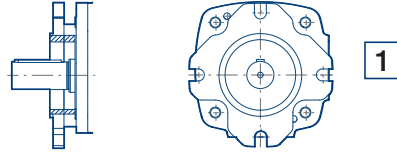

Keyway connection

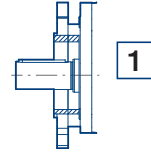

Variants

Rotation counterclockwise,
Suction port pump

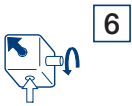

SAE 4-hole flange

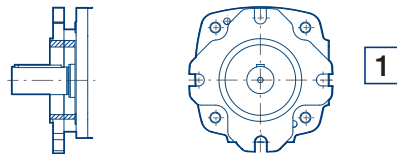

Keyway connection

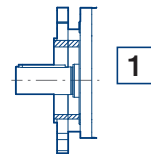

Rotation clockwise*,
Suction port pump



SAE 4-hole flange

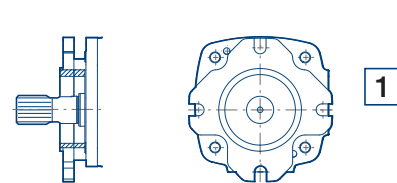

Involute gearing

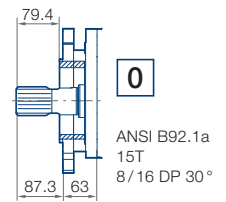

Rotation counterclockwise*,
Suction port pump

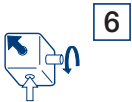

VDMA-4-hole flange

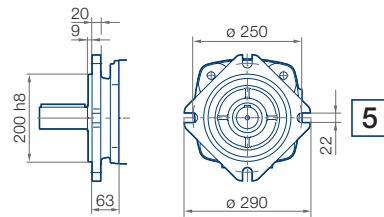

Keyway connection

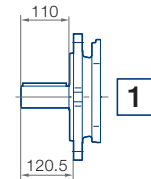

* Direction of rotation free selectable in the illustrated mounting flange/shaft end combination.

Measurement values – Airborne noise level (measuring location 1 m axial)

IPVS 3

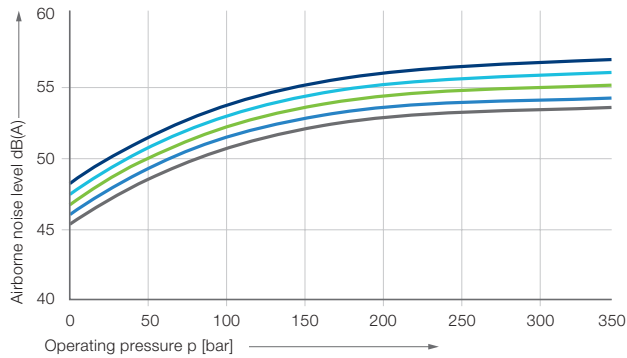

■ IPVS 3 – 10 ■ IPVS 3 – 8 ■ IPVS 3 – 6.3
■ IPVS 3 – 5 ■ IPVS 3 – 3.5

IPVS 4

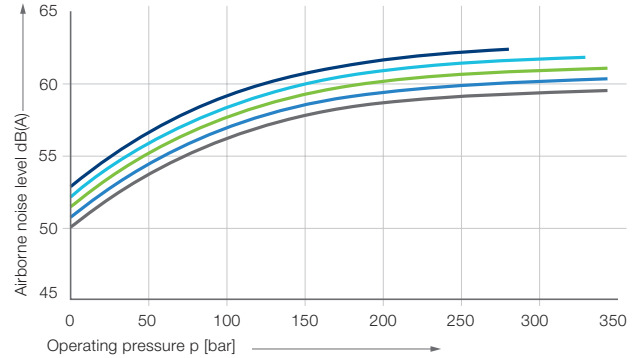

■ IPVS 4 – 32 ■ IPVS 4 – 25 ■ IPVS 4 – 20
■ IPVS 4 – 16 ■ IPVS 4 – 13

IPVS 5

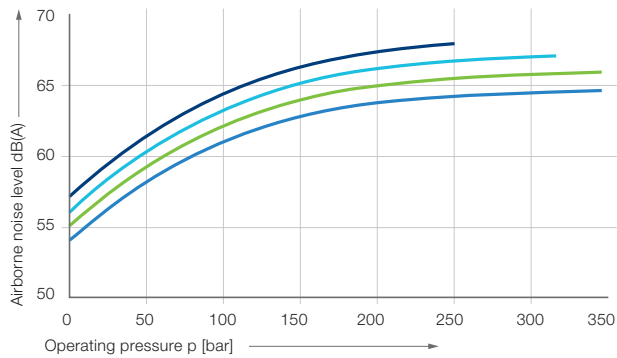

■ IPVS 5 – 64 ■ IPVS 5 – 50
■ IPVS 5 – 40 ■ IPVS 5 – 32

IPVS 6

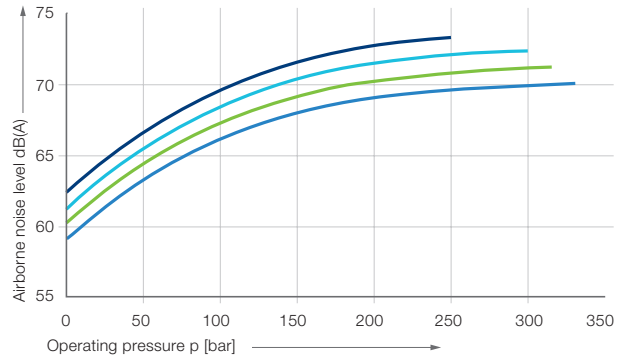

■ IPVS 6 – 125 ■ IPVS 6 – 100
■ IPVS 6 – 80 ■ IPVS 6 – 64

IPVS 7

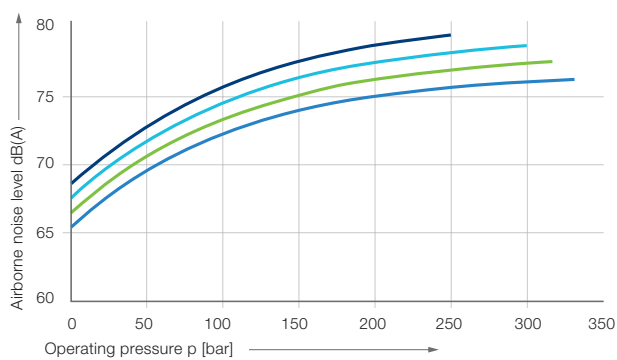

■ IPVS 7 – 250 ■ IPVS 7 – 200
■ IPVS 7 – 160 ■ IPVS 7 – 125

Measurement conditions

- Speed: 1 500 rpm
- Viscosity of pressure fluid: 46 mm²s⁻¹
- Operating temperature: 40 °C

Note

Measurement taken in a low-noise room. In a anechoic room the measurements are approx. 5 dB(A) lower.

Measurement values – Efficiency η_v and η_g

IPVS 3

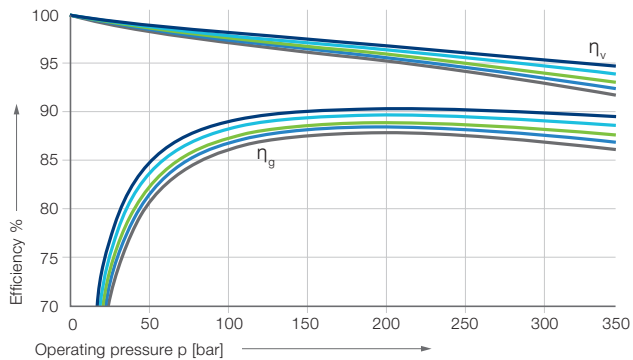

■ IPVS 3 – 10 ■ IPVS 3 – 8 ■ IPVS 3 – 6.3
■ IPVS 3 – 5 ■ IPVS 3 – 3.5

IPVS 4

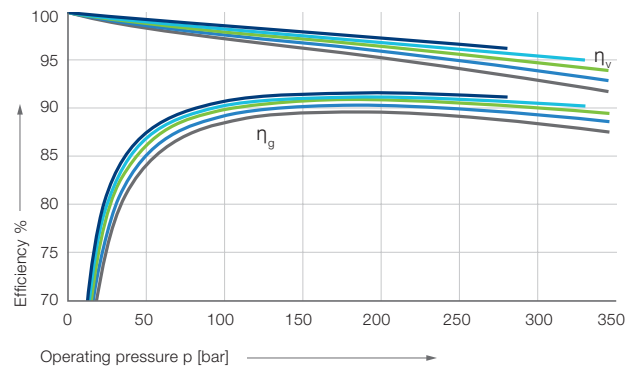

■ IPVS 4 – 32 ■ IPVS 4 – 25 ■ IPVS 4 – 20
■ IPVS 4 – 16 ■ IPVS 4 – 13

IPVS 5

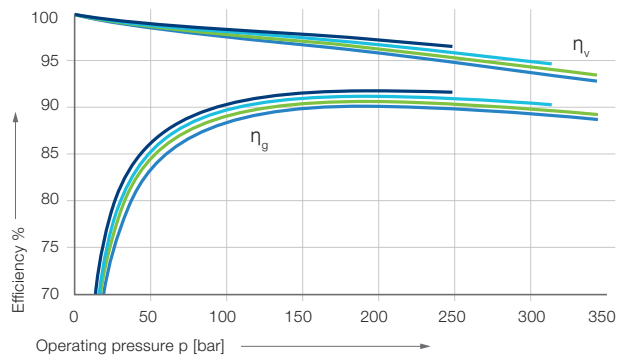

■ IPVS 5 – 64 ■ IPVS 5 – 50
■ IPVS 5 – 40 ■ IPVS 5 – 32

IPVS 6

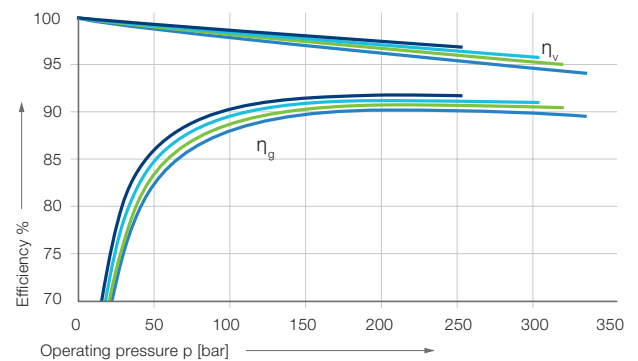

■ IPVS 6 – 125 ■ IPVS 6 – 100
■ IPVS 6 – 80 ■ IPVS 6 – 64

IPVS 7

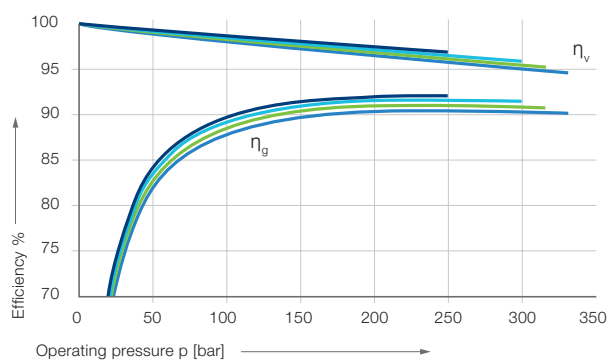

■ IPVS 7 – 250 ■ IPVS 7 – 200
■ IPVS 7 – 160 ■ IPVS 7 – 125

Measurement conditions

- Speed: 1 500 rpm
- Viscosity of pressure fluid: 46 mm²s⁻¹
- Operating temperature: 40 °C

Suction and pressure flange according to SAE...

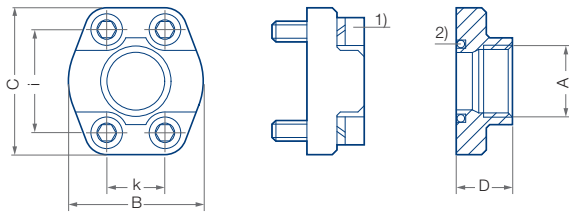

Wrench torque for screws according to ISO 6162

1) Screw EN ISO 4762

2) Round seal ring (O-Ring) ISO-R 1629 NBR

3) Special design. Deviation from SAE J 518 C Code 61

SAE flange no.	A Thread	B [mm]	C [mm]	D [mm]	E ¹⁾ Seal ring	i [mm]	k [mm]	S ²⁾ Thread	Max. pressure [bar]	
SAE J 518 C Code 61	10	G ½	46	54	36	18.66 – 3.53	38.1	17.5	M8	345
	11	G ¾	50	65	36	24.99 – 3.53	47.6	22.3	M10	345
	12	G 1	55	70	38	32.92 – 3.53	52.4	26.2	M10	345
	13	G 1-¼	68	79	41	37.69 – 3.53	58.7	30.2	M10	276
	14 ³⁾	G 1-½	82	98	50	47.22 – 3.53	69.9	35.7	M12	345 ³⁾
	30	G 1-½	78	93	45	47.22 – 3.53	69.9	35.7	M12	207
	15	G 2	90	102	45	56.74 – 3.53	77.8	42.9	M12	207
	16	G 2-½	105	114	50	69.44 – 3.53	88.9	50.8	M12	172
	17	G 3	124	134	50	85.32 – 3.53	106.4	61.9	M16	138
	17/2	G 3-½	136	152	48	98.02 – 3.53	120.7	69.9	M16	35
18	G 4	146	162	48	110.72 – 3.53	130.2	77.8	M16	34	
SAE J 518 C Code 62	50	G ½	46	54	36	18.66 – 3.35	40.5	18.2	M8	414
	51	G ¾	55	71	35	24.99 – 3.53	50.8	23.8	M10	414
	52	G 1	65	81	42	32.92 – 3.53	57.2	27.8	M12	414
	53a	G 1-¼	78	95	45	37.69 – 3.53	66.6	31.8	M14	414
	54	G 1-½	94	112	112	47.22 – 3.53	79.3	36.5	M16	414
	55	G 2	114	134	65	56.75 – 3.53	96.8	44.5	M20	400
	56	G 2-½	152	180	80	69.45 – 3.53	123.8	58.8	M24	400

Multi-flow pumps, pump combinations, pump combinations in order of type and size

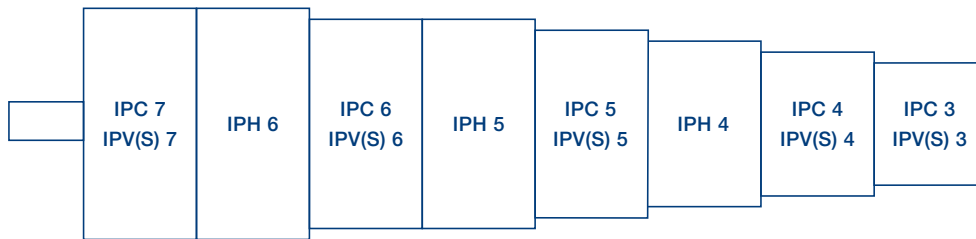

Combinations of IPVS pumps

- IPVS pumps of identical or different sizes can be combined in multiflow pumps.
- All sizes of the relevant pump volume are available as two- or three-flow pumps; four-flow pumps must be designed by Voith.
- The pumps are arranged in increasing order according to frame size and delivery.

Selection

1. Determine pressure ranges and define the appropriate pump serie(s).
2. Determine pump volume and select the appropriate size(s).
3. Define sequence of the pumps.
4. Check the torques.
5. Determine rotation and suction.
6. Specify mounting flange and shaft end.

Combinations of IPVS/IP...-pumps

- It is possible to combine IPVS pumps with other Voith pump series (e.g. medium-pressure pumps IPC).
- The pumps are arranged by types and sizes as shown in the illustration above.
- If identical types or identical sizes follow each other, the pump with the higher pump flow is placed closer to the drive.

Mounting, assembly

- Multi-flow pumps are generally mounted to the drive by means of a flange. All information about the flange design and shaft end is found in the catalog of the relevant pump series.
- For more information, for example about definition of the adapter housings, refer to brochure Multi-flow pumps.

Designs

Rotation and suction

clockwise (cw)   counterclockwise (ccw)



2

7



1

6



2

7



1

6



3

8

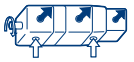

3

8



Special design

4

9

Special design

Mounting flange



0

1

4

5

7

For designs and dimensions, see catalog of the relevant pump series.

0 SAE-2-hole-flange

1 SAE-4-hole-flange

4 VDMA-2-hole flange

5 VDMA-4-hole flange

7 SAE-2-hole-flange (variant)

Shaft end



1

0

For designs and dimensions, see catalog of the relevant pump series

Allowed input torques

Size	A [Nm]	B [Nm]
3	160	80
4	335	190
5	605	400
6	1 050	780
7	1 960	1 200

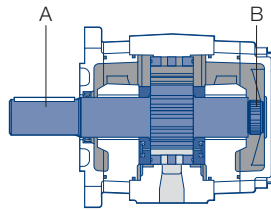

Type code

IPVS 3-3.5 1 0 1

Shaft end

- 0 Splined gear shaft ANSI B92.1a
- 1 Parallel shaft with keyway

Mounting flange

- 0 SAE-2-hole
- 1 SAE-4-hole
- 4 VDMA-2-hole
- 5 VDMA-4-hole
- 7 SAE-2-hole, variant

Rotation, Suction port

- 1 Clockwise rotation, suction port pump
- 6 Anti-clockwise rotation, suction port pump
- 4 Clockwise rotation, special design
- 9 Anti-clockwise rotation, special design

Delivery

Size	Delivery				
3	3.5	5	6.3	8	10
4	13	16	20	25	32
5	32	40	50	64	
6	64	80	100	125	
7	125	160	200	250	

Size

Type

This is a translated document
Original language: German.
Legally binding language version of the document: German.

Voith Group
St. Poeltener Str. 43
89522 Heidenheim
Germany

www.voith.com/hydraulic-systems

Contact:
Phone +49 7152 992 3
sales-rut@voith.com



VOITH

Inspiring Technology
for Generations